

AD-772 949

CH-47A DESIGN AND OPERATIONAL FLIGHT
LOADS STUDY

A. Herskovitz, et al

Boeing Vertol Company

Prepared for:

Army Air Mobility Research and Development
Laboratory

November 1973

DISTRIBUTED BY:

NTIS

National Technical Information Service
U. S. DEPARTMENT OF COMMERCE
5285 Port Royal Road, Springfield Va. 22151

**Best
Available
Copy**



DEPARTMENT OF THE ARMY
U.S. ARMY AIR MOBILITY RESEARCH & DEVELOPMENT LABORATORY
EUSTIS DIRECTORATE
FORT EUSTIS, VIRGINIA 23604

This program was conducted under Contract DAAJ02-72-C-0087 with The Boeing Company, Vertol Division.

The information presented herein is the result of an analytical effort to derive improved structural design criteria for transport-type helicopters based upon flight parameters measured on transport helicopters operating in Southeast Asia. This is one of four similar efforts being conducted concurrently to develop improved criteria for utility, crane, and observation as well as transport-type helicopters.

The report has been reviewed by the Eustis Directorate, U.S. Army Air Mobility Research and Development Laboratory and is considered to be technically sound. It is published for the exchange of information and the stimulation of future research.

This program was conducted under the technical management of Mr. Herman I. MacDonald, Jr., Technology Applications Division.

in

Unclassified
Security Classification

AD-772 949

DOCUMENT CONTROL DATA - R & D		
<i>(Security classification of title, body of abstract and indexing annotation must be entered when the overall report is classified)</i>		
1. ORIGINATING ACTIVITY (Corporate author) Boeing Vertol Company A Division of The Boeing Company Philadelphia, Pennsylvania		2a. REPORT SECURITY CLASSIFICATION Unclassified 2b. GROUP
3. REPORT TITLE CH-47A DESIGN AND OPERATIONAL FLIGHT LOADS STUDY		
4. DESCRIPTIVE NOTES (Type of report and inclusive dates) Final Report		
5. AUTHOR(S) (First name, middle initial, last name) A. Herskovitz H. Steinmann		
6. REPORT DATE November 1973	7a. TOTAL NO. OF PAGES 50-53	7b. NO. OF REFS 7
8a. CONTRACT OR GRANT NO. DAA102-72-C-0087 PROJECT NO. Task 1F162204AA8201	9a. ORIGINATOR'S REPORT NUMBER(S) USAANRDL Technical Report 73-40 9b. OTHER REPORT NO(S) (Any other numbers that may be assigned this report) D210-10579-1	
10. DISTRIBUTION STATEMENT Approved for public release; distribution unlimited.		
11. SUPPLEMENTARY NOTES	12. SPONSORING MILITARY ACTIVITY Eustis Directorate U. S. Army Air Mobility R&D Laboratory Fort Eustis, Virginia	
13. ABSTRACT The purpose of this study was to evaluate the adequacy of current structural design criteria for future cargo- and transport-type helicopters based on the design, development, and operational use of the CH-47A Chinook helicopter. It was concluded that current structural design criteria are adequate to insure structural safety. Specifications for procurement of new helicopters should be modified to provide the most realistic mission description possible for fatigue design, with the objective of simplifying the design task. While analyzing CH-47A operational data, several deficiencies were identified in the data acquisition and analysis process. The deficiencies can be overcome in future field survey work by cooperative advanced planning between the cognizant Army agency, the helicopter manufacturer, and the contractor responsible for data acquisition and analysis. Current state-of-the-art recording systems and automated data reduction and analysis techniques are recommended for future surveys.		

NATIONAL TECHNICAL
INFORMATION SERVICE
DISTRIBUTION STATEMENT
UNCLASSIFIED

DD FORM 1473
1 NOV 65

REPLACES DD FORM 1473, 1 JAN 64, WHICH IS
OBSOLETE FOR ARMY USE.

Unclassified
Security Classification

Unclassified

Security Classification

14	KEY WORDS	LINK A		LINK B		LINK C	
		ROLE	WT	ROLE	WT	ROLE	WT
	CH-47A helicopter Flight 1 add study Structural design criteria Cargo-type helicopters Transport-type helicopters						

ia

Unclassified

Security Classification

Task 1F162204AA8201
Contract DAAJ02-72-C-0087
USAAMRDL Technical Report 73-40
November 1973

CH-47A DESIGN AND OPERATIONAL
FLIGHT LOADS STUDY

By

A. Herskovitz
H. Steinmann

Prepared by

Boeing Vertol Company
(A Division of The Boeing Company)

for

EUSTIS DIRECTORATE
U.S. ARMY AIR MOBILITY RESEARCH AND DEVELOPMENT LABORATORY
FORT EUSTIS, VIRGINIA

Approved for public release;
distribution unlimited.

ii

ABSTRACT

The purpose of this study was to evaluate the adequacy of current structural design criteria for future cargo- and transport-type helicopters based on the design, development, and operational use of the CH-47A Chinook helicopter. It was concluded that current structural design criteria are adequate to insure structural safety. Specifications for procurement of new helicopters should be modified to provide the most realistic mission description possible for fatigue design, with the objective of simplifying the design task.

While analyzing CH-47A operational data, several deficiencies were identified in the data acquisition and analysis process. The deficiencies can be overcome in future field survey work by cooperative advanced planning between the cognizant Army agency, the helicopter manufacturer, and the contractor responsible for data acquisition and analysis. Current state-of-the-art recording systems and automated data reduction and analysis techniques are recommended for future surveys.

TABLE OF CONTENTS

	<u>Page</u>
ABSTRACT	iii
LIST OF ILLUSTRATIONS	vi
LIST OF TABLES	vii
LIST OF ABBREVIATIONS AND SYMBOLS	viii
1. INTRODUCTION	1
2. MISSION PROFILE	3
3. FATIGUE DAMAGE	13
4. AIRCRAFT CONFIGURATION	24
5. OPERATING LIMITATIONS	32
6. CONCLUSIONS AND RECOMMENDATIONS	39
7. LITERATURE CITED	42
DISTRIBUTION	43

Preceding page blank

LIST OF ILLUSTRATIONS

<u>Figure</u>		<u>Page</u>
1	Percentage of V_{ne} Occurrence Shows Importance of Extracting Data in the Form to be Used in Analysis	7
2	Comparison of Mission Profiles and Operational Use of the CH-47A Helicopter	12
3	Normal Load Factor Exceedance for Operational Data and Mission Profiles	14
4	Elements of Fatigue Life Evaluation	16
5	CH-47A Aft Rotor Blade Spar Fatigue Load Exceedance for Four Mission Profiles	22
6	CH-47A Aft Pivoting Actuator Fatigue Load Exceedance for Four Mission Profiles	22
7	Structural Airspeed Limitations for CH-47 Helicopters at 6,000 Feet Density Altitude	31
8	Percent of Steady-State Time for 98.2 Hours (USA) and 135.9 Hours (SEA) of CH-47A Operational Data at Gross Weights Below 28,000 Pounds	34
9	Percent of Steady-State Time for 9.4 Hours (USA) and 18.9 Hours (SEA) of CH-47A Operational Data at Gross Weights Above 28,000 Pounds	35
10	CH-47A Maneuvering Load Factors Relative to Design Envelope	37
11	Operational Load Factors Extrapolated to High Flight Hours	37

LIST OF TABLES

<u>Table</u>		<u>Page</u>
I	Summary of Significant Characteristics of A, B, and C Models of the Chinook Helicopter . . .	2
II	Criteria Used for Determination of Flight Segment from Measurements in References 1 and 2	5
III	Redistribution of Time for Mission Segments . . .	8
IV	Load Factor (n_z) Peak Frequency as Determined From CH-47A Flight Strain Survey	10
V	Comparison of Various Fatigue Mission Profiles by Operating Condition and by Mission Segment . .	11
VI	CH-47A Part Lives for Various Mission Profiles . .	18
VII	Fatigue Damage Rate for Aft Rotor Blade Spar and Aft Pivoting Actuator by Flight Condition and Mission Profile	20
VIII	Summary of 207 CH-47 Changes by Helicopter System and Reason for Change	25
IX	Summary of CH-47 Changes to Improve Fatigue and Ultimate Strength of Components	27

LIST OF ABBREVIATIONS AND SYMBOLS

Accel.	Acceleration
A/R	Autorotation
cg	Center of gravity
Des	Descent
ECP	Engineering change proposal
EJS	Engineering job sheet
g	Acceleration due to gravity, ft/sec ²
G-A-G	Ground-air-ground
GW	Gross weight, lb
H _d	Density altitude, ft
IAS	Indicated airspeed
ISA	International standard atmosphere
n _z	Load factor in helicopter z-axis (vertical)
PPD	Partial power descent
SRD	Service revealed difficulty
TO	Takeoff
V _H	Airspeed limit, used interchangeably with V _{ne}
V _{ne}	Airspeed limit, used interchangeably with V _H
Wt	Weight
σ	Standard statistical deviation
⇒	Implies

1. INTRODUCTION

BACKGROUND

CH-47A operational data were collected by the U.S. Army in both simulated and actual combat conditions as reported in References 1 and 2. The combat data were separately analyzed by the Boeing Company under U.S. Army contract and reported in Reference 3.

The twin tandem CH-47A Chinook helicopter was designed to meet U.S. Army medium lift requirements as a personnel transport and cargo carrier. Cargo can be transported either internally or externally. The CH-47B and CH-47C models of the Chinook were developed to meet increased payload and range requirements, with particular concern for operations in hot climates. Table I summarizes some significant characteristics of the three models.

This design and operational flight loads study is centered about the CH-47A model of the Chinook because the operational data were obtained on the A model. Some of the lessons learned from the CH-47A field data resulted in design improvements incorporated in the B and C models. CH-47B and CH-47C design features which are based on CH-47A experience are noted in Section 4.

DESCRIPTION OF TASKS

This report follows the basic sequence of the separate studies conducted under the contract:

- | | |
|--|--|
| Section 2
MISSION PROFILE | Compares two independent analyses of combat data, constructs a new mission profile based on field data, and compares various mission profiles. |
| Section 3
FATIGUE DAMAGE | Evaluates load spectrum, fatigue damage rate, and calculated fatigue life for six components and various mission profiles. |
| Section 4
AIRCRAFT
CONFIGURATION | Correlates configuration changes in the CH-47 history with mission profile changes. |
| Section 5
OPERATING
LIMITATIONS | Investigates the factors which limited the CH-47A operations in simulated and actual combat conditions. |

TABLE I. SUMMARY OF SIGNIFICANT CHARACTERISTICS
OF A, B, AND C MODELS OF THE CHINOOK
HELICOPTER

DESCRIPTION	MODEL		
	CH-47A	CH-47B	CH-47C
Number of blades per rotor	3	3	3
Airfoil	Symmetrical	Cambered	Cambered
Rotor diameter, ft	59	60	60
Constant chord, in.	23	25.25	25.25
Rotor speed, rpm-Power on	230	225-230	235-245 ①
-Power off	261	261	261
Gross weight, lb-Design	28,550	33,000	33,000
-Maximum	33,000	40,000	46,000 ①
Load factor, n_z , at design GW	-0.5 to 2.67	-0.5 to +3	-0.5 to +3
Limit true airspeed, kt, at design GW	130	170	170
Payload, lb, at SL/STD, 50-mile radius	12,300	17,400	20,950

NOTE: ① CH-47C capability at 50,000 pounds gross weight and 250 rpm has been substantiated by the contractor and evaluated by the U.S. Army.

Section 6
CONCLUSIONS AND
RECOMMENDATIONS

Recommends adequacy and/or deficiencies in structural design criteria for cargo and transport-type helicopters. Additional recommendations are made for state-of-the-art improvements in field data acquisition and analysis techniques.

2. MISSION PROFILE

This report section comprises a comparison of mission profiles as used to structurally design and evaluate the CH-47A with the actual helicopter usage as reported in References 1, 2, and 3.

Mission profiles are used for various evaluations in helicopter design and analysis, such as payload-range, duty cycle, low cycle and high cycle part fatigue, and part wear. The philosophy of mission profile construction for the various evaluations is beyond the scope of this study, but the philosophy must necessarily vary with the purpose and risks associated with a particular evaluation.

This section is directed at the fatigue mission profile:

Fatigue Mission Profile is used for fatigue design and to calculate the safe-life retirement interval for critical components. It is also used to design wear-critical components and to calculate required overhaul intervals.

DATA SOURCE EVALUATION

An understanding of the content and limitations of the field data sources is essential to a rational interpretation of the information.

The total accuracy of a measurement should be considered, but cannot readily be established from the information available. The "Quality Control Values" tabulated in References 1 and 2 indicate that reasonable procedures were used to minimize data reduction errors for the measured values. However, the accuracies of sensors, amplifiers, and power sources were not included, and procedures for establishing calibration factors were not identified. The lack of information on accuracy does not preclude an analysis of the data, but the possible implications of errors in the data should be considered in forming conclusions.

The source of gross weight information was not specified. It is assumed that this information comes from a log maintained by flight crews.

No information on center of gravity distribution is provided.

Flight Segments (steady state, ascent, descent, and maneuver) were identified by the data characteristics of longitudinal control displacement, collective control displacement, airspeed, altitude, and normal acceleration as shown in Table II. Observe that yaw and roll displacements cannot be identified from the data.

Acceleration Peaks were not evaluated between 0.8 and 1.2g in the data reduction process. This threshold limitation would exclude, for example, a steady 33° banked turn. Acceleration peaks less than 0.8g and greater than 1.2g were subdivided into maneuver- or gust-induced accelerations. An acceleration peak was classified as maneuver induced if either or both of the longitudinal and collective control positions were displaced just prior to the observed acceleration. Using the same example as before, the load factor developed in a turn could be classified as either maneuver or gust induced depending on the longitudinal and/or collective control exercised in conjunction with the turn.

Finally, the data samples for simulated and actual combat operations each represent the activity of one operational unit in a limited locale for a time period much less than a year. Conclusions drawn from this data with respect to aircraft utilization should consider the possible effects of different missions and environments.

DATA ANALYSIS PROCEDURE

The operational data obtained in actual combat conditions were separately analyzed and reported in References 2 and 3. Each analysis used the same reduced data, but apparently with different objectives. Reference 2, produced for USAAMRDL by Technology, Inc., appears to be tailored for easy comparison to operational data gathered on other types of helicopters. Reference 3, prepared for USAAVSCOM by the Boeing Company, was compiled for the specific purpose of fatigue mission profile evaluation.

Except for the parameter increments chosen, the documents were found to be in good agreement with respect to gross weight, density altitude, rotor speed, and acceleration peak occurrences. The Reference 2 analysis included a 39-minute flight at approximately 37,000 pounds gross weight in a "greater than 32,000 pound" increment. The gross weight for this flight was more accurately defined in Reference 3.

TABLE II. CRITERIA USED FOR DETERMINATION OF FLIGHT SEGMENT FROM MEASUREMENTS IN REFERENCES 1 AND 2

Flight segment	Transient			Steady state
Measurement	Ascent	Descent	Maneuver	
Longitudinal control position	Not steady	Not steady	Not steady	Relatively steady
Collective control position	Not steady	Not steady	Not steady	Relatively steady
Airspeed	Frequent changes	Frequent changes	Frequent changes	Steady or smooth change
Altitude	Frequent changes (increasing)	Frequent changes (decreasing)	Frequent changes	Steady or smooth change
Normal acceleration, n_z	No criteria	No criteria	Usually very active	No criteria

Evaluation of airspeed was significantly different in the two documents. In Reference 2, indicated airspeed (IAS) is shown as a time increment within designated boundaries of gross weight, altitude, and indicated airspeed. In Reference 3, the analyst was interested in airspeed as a percentage of V_{ne} (never-exceed airspeed = flight manual limitation). Since V_{ne} varies with gross weight, altitude, and rotor speed, the percent of V_{ne} was calculated at each discrete time increment of data reduction. The results were presented as a histogram of percent of V_{ne} increments.

An attempt was made to express the IAS data of Reference 2 in percent of V_{ne} . The results, shown in Figure 1, are less than satisfactory. The wide band of possible solutions arises from the large variation of V_{ne} within the gross weight, altitude, and airspeed boundaries which define an IAS occurrence. Similar problems would be encountered in attempting to determine IAS distribution from the percent of V_{ne} histograms.

MISSION PROFILE DERIVATION

Mission Segment Analysis

The data analysis procedure employed in References 1 and 2 separated transient flight conditions into three flight segments identified as ascent, descent, and maneuver. A fourth segment, steady state, included climbing, level, and descending steady flight conditions. The ascent segment also included "the takeoff and climb to the initial steady-flight altitude", and the descent segment included "the unsteady part of flare and landing". Table III shows that the ratio of maneuvering time from level flight conditions to the time spent in steady level flight was significantly less than the maneuver to steady time ratios obtained in ascent and descent conditions. The acceleration to climb airspeed and flare to landing can be accepted as maneuvers peculiar to the ascent and descent segments respectively. However, other maneuvers such as turns, pull-ups, pushovers, and control reversals should be nearly as common to constant altitude operations as to climbing and descending flight. In addition, in Reference 2, normal load factor peaks occur 2.8 and 4.1 times more frequently in the maneuver segment than in the ascent and descent segments respectively.

The observations of the preceding paragraph led to the conclusion that a significant amount of the time in the ascent and descent mission segments of References 1 and 2 was, in reality, steady ascent and descent. Accordingly, the flight time was re-allocated as shown in Table III.

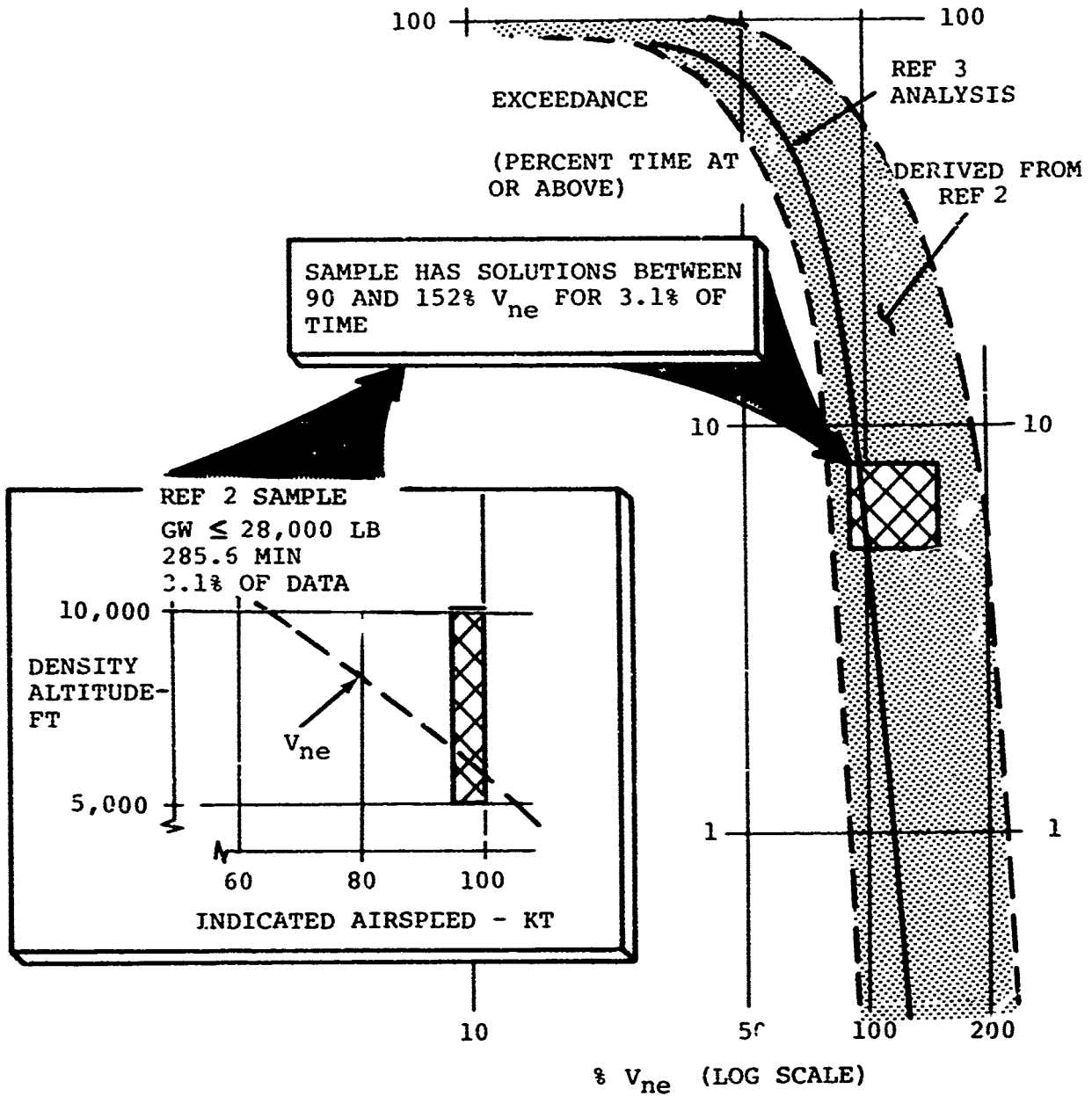

Figure 1. Percentage of V_{ne} Occurrence Shows Importance of Extracting Data in the Form to be Used in Analysis.

TABLE III. REDISTRIBUTION OF TIME FOR MISSION SEGMENTS

Description	Flight Segment Percent Occurrence										Derived Mission Profile	
	Ascent			Descent			Maneuver			Steady State		
	Ref 1	Ref 2	Ref 1	Ref 2	Ref 1	Ref 2	Fef 1	Fef 2	Ref 1	Ref 2		
Values in Ref 1 & 2 Reports	11.80	12.50	16.81	19.97	6.48	1.87	64.91	65.66			-	
<u>Redistribution used for mission profile derivation</u>												
Steady level (+500 fpm R/C)							63.48	59.40			60	
Steady ascent (> 500 fpm R/C)	7.11	8.28					0.97	4.36			11	
Steady descent (<-500 fpm R/C)			11.71	15.60			0.46	1.90			16	
Maneuver-from level flight					6.48	1.87						
Maneuver in Ascent	4.69	4.22									13	
Maneuver in Descent			5.10	4.37								
	TOTAL,										100	

Method of redistribution of time segments

1. Steady-state segment breakdown is based on rate-of-climb data reported in References 1 and 2.
2. Ascent and descent segment breakdown is based on the following logic:
 - A. Thirty seconds per flight is assumed for acceleration to climb airspeed in ascent segment, and thirty seconds per flight is assumed for landing flare in descent segment.
 - B. The ratios of times for ascent maneuvers to steady ascent and descent maneuvers to steady descent were assumed equal to the ratio of times for level maneuvers to steady level flight. The ratio, determined from level conditions, was applied to all ascent and descent time except for the acceleration and flare time identified in (A) above.

Normalization of Mission Profiles

The fatigue mission profiles defined in References 4 and 5 include some operating conditions with occurrence factors expressed in number of events per unit time. For comparison of mission profiles, it was desirable to express all mission segments in percent of the total mission profile.

The normalization of mission profiles was accomplished by the following process:

1. The time required to conduct a maneuver was determined from CH-47A flight strain survey testing, as shown in Table IV.
2. Each operating condition in the mission profile was expressed as a fraction of a common time base (1 hour was used). The sum of these fractions then exceeded unity.
3. The fractional times were proportionately normalized to unity and expressed in percent of the total mission profile.

The normalized mission profiles are displayed in Table V for Reference 4 (current) and Reference 5 (AR-56). The design mission profile from Reference 6 and the mission profile derived in the Derived Mission Profile section are also shown in Table V.

The derived mission profile is compared to the operational data and to the original design, current, and AR-56 mission profiles in Figure 2.

Derived Mission Profile

The fatigue mission profile derived from the operational data of References 1, 2, and 3 is shown in Table V. The distribution of time into 4 mission segments was based on the analysis shown in Table III. The basis of other distribution factors follows:

1. Gross weight Increments selected to be consistent with available CH-47A flight strain survey test data.

<u>Gross Weight (lb)</u>	<u>Cumulative % Time at or Below</u>		
	<u>Derived Profile</u>	<u>Ref 1</u>	<u>Ref 2 & 3</u>
25,000	66	85	64
28,550	92	92.5	90
33,000	100	99.5	99.8

TABLE IV. LOAD FACTOR (n_z) PEAK FREQUENCY AS DETERMINED FROM CII-47A FLIGHT STRAIN SURVEY

Mission Profile Operating Condition	Flight Records		Load Factor (n _z) Peaks/1000														
	No.	Length Sec	Load Factor Range +0.05										Load Factor				
			0.2	0.7	0.8	0.9	1.1	1.2	1.3	1.4	1.75						
<u>Steady Conditions</u>																	
Hover	6	20.7								174.0							
Transition	17	48.5								74.2							
0.2VH	9	26.5								136.0							
0.7VH, 0.8VH, 0.9VH	12	35.6								404.0							
VH	5	19.6								367.0							
1.1VH	5	15.2								237.0							
1.15VH	12	39.8								181.0							
1.2VH	7	24.6								146.0							
Climb	5	312.0								46.0							
Partial power descent	12	119.0							90.9	60.6							
Autorotation	17	116.0							31.0	31.0							
<u>Maneuver Conditions</u>																	
Sideward flt, rearward flight	9	26.5								136.0							
Acceleration to climb airspeed	1	30.0								120.0							
Pull-up, 1.4g & A/P	6	7.10								507.0							
Pull-up, 1.75g	3	7.10															
Pushover	1	7.10								507.0							
Left turn	5	53.0															
Right turn	5	64.7															
Longitudinal control reversal	5	7.50								55.6							
Lateral control reversal	5	8.00								480.0							
Directional control reversal	5	6.40								450.0							
Landing approach and flare	4	10.0															

NOTES: ① n_z peaks/hr = (No. of n_z peaks observed in load factor range ÷ record length in seconds) x 3600

② Record length for steady conditions = sum of all flight records

③ Record length for maneuver conditions = length of longest flight record

TABLE V. COMPARISON OF VARIOUS FATIGUE MISSION PROFILES BY OPERATING CONDITION AND BY MISSION SEGMENT

Operating Condition	CH-47A Mission Profile Percent Occurrence							
	Mission 114-0-117.12 Gr Wt All	Current 114-SS-001			AR-56 Ch other Gr Wt All	Derived From Operational Data Ref (1), (2), and (3)		
		Gr Wt 25,000 Lb	Gr Wt 28,550 Lb	Gr Wt 33,000 Lb		Gr Wt 25,000 Lb	Gr Wt 28,550 Lb	Gr Wt 33,000 Lb
Steady level segment								
Level flight - Hover	10.0	4.0	0.8	4.2	10.5	3.2	0.4	0.4
- Cruise	10.0	5.0	1.2	4.8		4.8	2.0	1.5
- 1000 ft					4.4			
- 2000 ft					1.8			
- 3000 ft					1.9			
- 4000 ft		10.0	2.0	4.0	4.4	7.1	4.0	0.8
- 5000 ft					7.0			
- 6000 ft					8.8	12.7	5.4	1.9
- 7000 ft					29.7	7.9	1.2	0.7
- 8000 ft	10.0	16.0	4.2	11.6	7.4	7.5	1.4	0.2
- 9000 ft	10.0	2	0.4	1.6	1.6	1.6	0.1	0.2
- 10000 ft		2.0	0.4	1.6	0.9	1.6	0.1	0.2
- 11000 ft								
- 12000 ft								
- 13000 ft								
- 14000 ft								
- 15000 ft								
- 16000 ft								
- 17000 ft								
- 18000 ft								
- 19000 ft								
- 20000 ft								
Total steady level	100	47.0	8.0	32.0	74.9	39.6	17.6	4.8
Steady ascent segment								
Climb - Max 'full' power	0.0				2.0	7.2	2.9	0.9
- Takeoff power					0.9			
Total steady ascent	0	0	0	0	2.9	7.2	2.9	0.9
Steady descent segment								
Partial power descent					1.3	7.9	3.1	1.0
Autotrottle	4.0				0.9	2.7	1.0	0.3
Power Dive					2.2			
Total steady descent	4	0	0	0	6.4	10.6	4.1	1.3
Maneuver segment								
Ground condition								
- Rot start	0.0				0.9			
- Taxi	0.0							
- Taxi to hold					0.5			
Taxiout	0.0				0.6			
Forward flight	0.0				0.9			
Rearward flight	0.0				0.4			
Approach to flight airspeed						2.7	1.0	0.3
Combinational								
- Pull-up 1.0	0.0	1.0	0.2	0.2	0.4	0.025	0.025	0.008
- Pull-up 1.5							0.001	
- A pull-up	0.0				0.2			
- Pushover 1.0							0.001	
- Pushover 1.5								
- Change to A 0	0.0				0.1			
- Change to 0.0	0.0							
Roll - Hover					2.4			
- Left level	0.0				2.2	1.1	0.4	0.2
- Right level	0.0				0.2	1.1	0.4	0.2
- Left descending	0.0				0.2			
- Right descending	0.0				0.2			
Control Reversal								
- Hover					0.2			
- Intermediate		0.25	0.1	0.2		0.33	0.13	0.04
- Aerial		0.5	0.1	0.4	1.0	0.33	0.13	0.04
- Interchange		0.25	0.05	0.2		0.33	0.13	0.04
- Descending					0.3			
Yawing	0.0							
Landing - Approach					3.2			
- Flare	1.0	1.2	0.25	1.0		2.7	1.0	0.3
- A 0 to landing	0.0				0.3			
Total maneuver	1.0	10.0	2.0	8.0	16.1	8.65	3.21	1.12
Mission gross weight total	100.0	59.0	15.0	40.0	100.0	66.05	25.21	8.12
Mission profile total	100				100			
Mission Segment Summary								
Steady level	40	30			71.0		40	
Steady ascent	0	0			2.9		11	
Steady descent	4	0			6.4		16	
Maneuver	10	20			26.1		13	
Mission segment total	100	100			100.0		100	

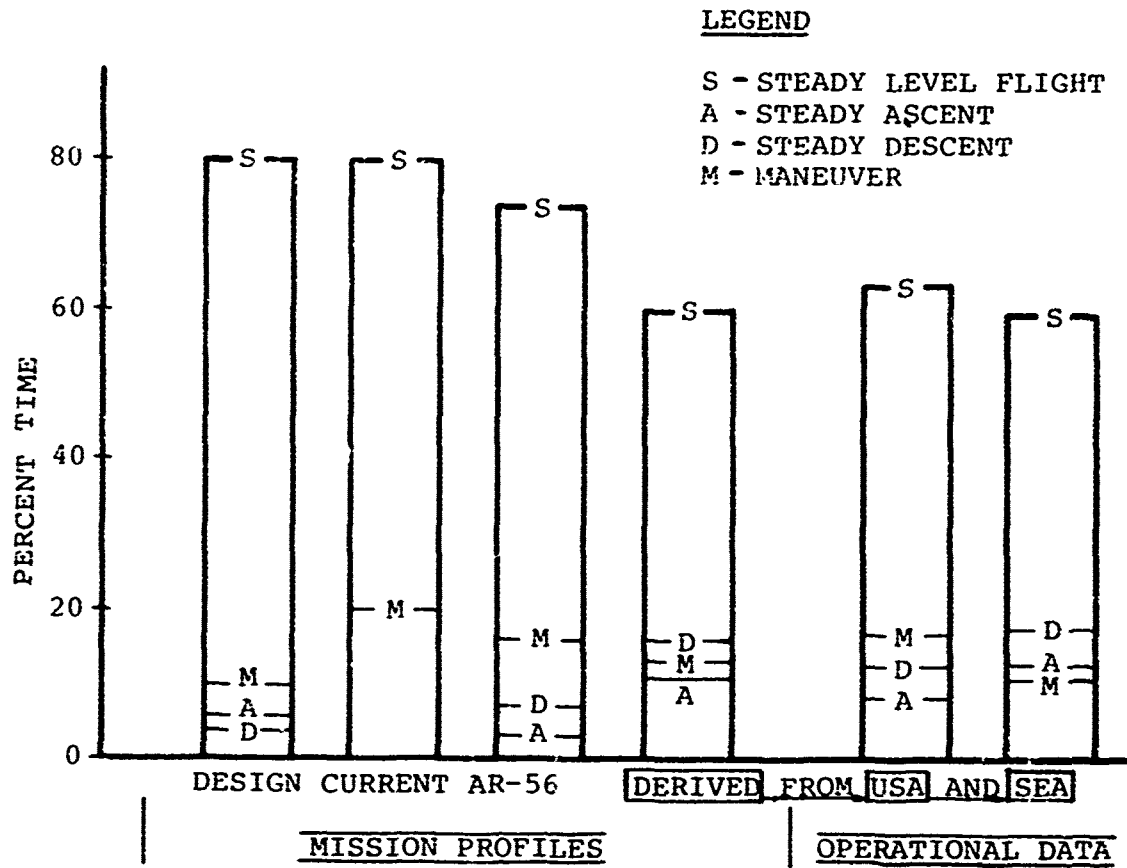

Figure 2. Comparison of Mission Profiles and Operational Use of the Ch-47A Helicopter.

2. Airspeed Distribution based on Reference 3 analysis of time at percent of V_{ne} (never-exceed airspeed).
3. Steady descent Distribution between partial power descent and autorotation based on Reference 5 distribution (AR-56).
4. Acceleration to climb airspeed and landing flare Occurrence based on Table III analysis of References 1 and 2.

Occurrence, %

Derived Profile	Ref 1	Ref 2
4.0	3.9	3.8

5. Symmetric maneuvers, turns, and control reversals Occurrence selected to obtain normal load factor (n_z) distribution consistent with References 1 and 2.

The incremental normal load factor exceedance for combined gust and maneuver load factor peaks is shown in Figure 3. Operational data is shown as a 0.1g band representing the range of values reported in References 1 and 2. Mission profile exceedance was determined from CH-47A flight strain survey data, Table IV, in conjunction with the operating condition occurrence from Table V. The derived mission profile is shown to reasonably represent the operational experience with respect to the frequency and magnitude of load factor peaks. The operational load factor peak occurrence frequency is significantly exceeded in both the current and AR-56 mission profiles. The maximum load factor to be considered for fatigue analysis is evaluated in Section 3.

3. FATIGUE DAMAGE

In this section the effect of mission profiles on fatigue life for six critical components is evaluated.

It was intended to include a comparison of design values to those resulting from operational use of the CH-47A helicopter. However, such a comparison does not provide useful information for future helicopter design for the following reasons:

- a. Fatigue loads measured during developmental testing of the CH-47A exceeded predicted values, particularly in the control system. Subsequent redesign of components was based on trade-offs considering related costs and structural performance.

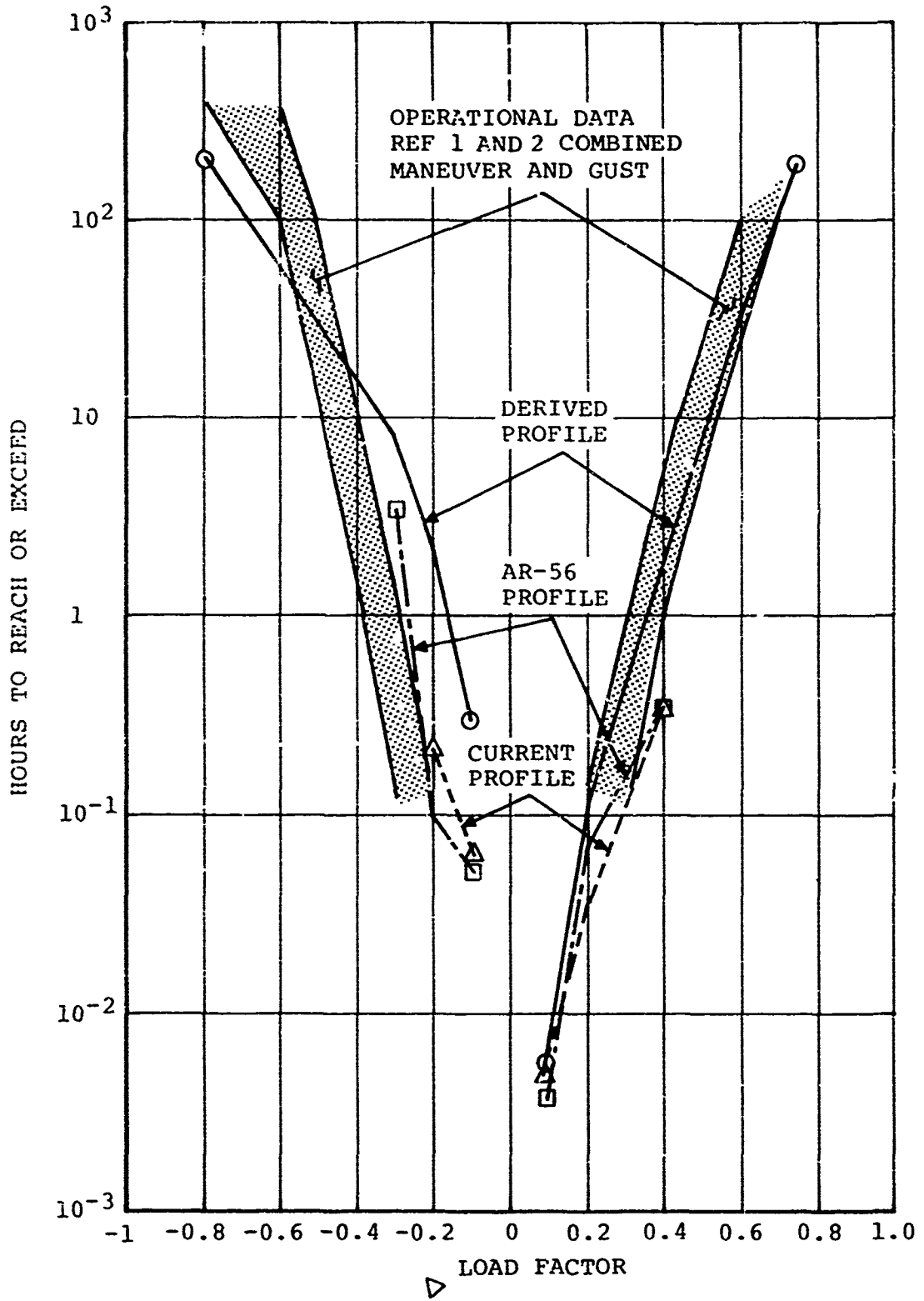

Figure 3. Normal Load Factor (n_z) Exceedance for Operational Data and Mission Profiles.

- b. Fatigue methodology has been changed since the CH-47A was designed. Of particular importance, the current use of statistically significant mean minus three standard deviation ($M-3\sigma$) endurance limits was not used for CH-47A design.

Any discussion of fatigue evaluation requires some background knowledge of the method used to assess damage. Figure 4 displays the relationship of the elements required to calculate a component life. The Boeing Vertol Company currently employs the following criteria:

Fatigue Strength

- S-N curve shape is determined from coupon tests and makes maximum use of available sources such as MIL-HBK-5B.
- Full-scale flight hardware is bench fatigue tested to failure. A minimum of six failed specimens is desired.
- Endurance limit at the assumed stress asymptote is evaluated statistically assuming a log-normal distribution (the number of cycles at which the fatigue strength is assumed asymptotic varies with the material). The lowest endurance limit of the following is used for life calculations:
 - a. bottom of data scatter
 - b. 80% of the mean value
 - c. three standard deviations below the mean value ($\text{mean} - 3\sigma$).

Fatigue Loads

- Calculated or measured loads at flight conditions consistent with the expected use of the helicopter (design mission profile) are used.
- Top-of-scatter fatigue loads are assumed to exist continuously for steady flight conditions such as level flight, climb, and descent.
- Cycle counted fatigue loads are used for transient flight conditions such as turns, pull-ups, and landing flares.

Calculation Method

- Minor's cumulative damage theory is used.

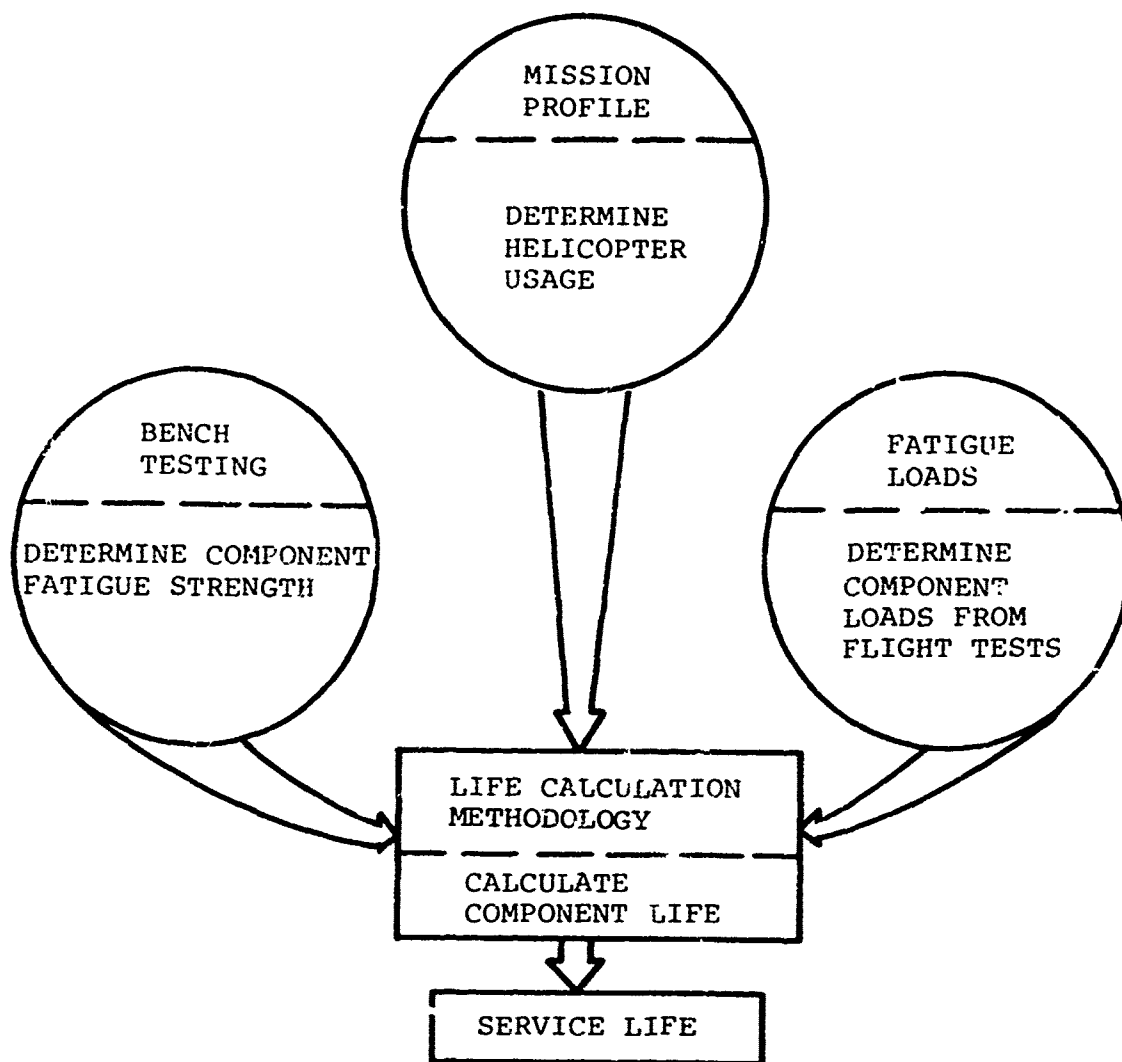

Figure 4. Elements of Fatigue Life Evaluation.

Mission Profile

- Initial fatigue evaluation is made utilizing the design mission profile.
- The design mission profile is reevaluated and modified as necessary based on field experience. The field experience could be fatigue failures, observer reports, or operational load surveys (as in this case).

It should be noted that some of the previously discussed fatigue evaluation criteria were not in use at the time of the Reference 6 component life evaluation. In particular and of most importance is that bottom of scatter endurance limits were used in the Reference 6 document.

COMPONENT LIFE

Calculated part lives for six critical aft rotor components for each of four mission profiles, along with the endurance limits used, are presented in Table VI. The wide range of part lives requires some explanation.

The basic mission profiles defined in Table V are not completely descriptive of all the factors which influence part life. The following information supports the mission descriptions:

Gross Weight

The design mission profile, Reference 6, was evaluated using the worst loading from any flight data up to 33,000 pounds.

The current, Reference 4, AR-56, Reference 5, and derived mission profiles used flight test data at weights consistent with Table V.

Center of Gravity

The design mission profile assumed a cg distribution of 25% maximum forward, 50% mid, and 25% maximum aft cg for all flight conditions.

All other mission profiles were evaluated with level flight time distributed equally between extreme forward and aft cg, and maneuvers were assumed to occur at the cg which produced the highest load on the part.

TABLE VI. CH-47A PART LIVES FOR VARIOUS MISSION PROFILES

Component Part Number	Fatigue Life (Hours)					Endurance Limit	
	Mission Profile					Derived	Current ^② AR-56 Derived
	Design	Current	AR-56	Derived	Design ^①		
Aft Blade Spar 114R1042-2	50,100	4,920	8,930	52,550	± 25,000 psi	± 23,200 psi	
Aft Blade Socket 114R1043-4	5,940	3,820	5,860	11,690	± 48,200 in - lb	± 47,900 in - lb	
Aft Rotor Shaft 114D3002-7, -8	9,440	9,600	20,200	33,340	± 216,000 in - lb	± 233,000 ^③ in - lb	
Aft Rotating Swashplate 114R3324-1	17,800	1,565	4,810	4,490	± 1,035 lb	± 881 lb	
Aft Stationary Swashplate 114R3350-8	423,000	23,400	40,400	67,200	± 1,600 lb	± 1,250 lb	
Aft Pivot Actuator 114H4000-20	1,400	1,340	1,470	1,350	± 1,610 lb	± 1,193 lb	

① Endurance limit based on bottom of scatter

② Endurance limits based on lesser of bottom of scatter, 0.8 mean, or mean - 3σ

③ Redesigned shaft (shot peened)

Altitude

No altitude distributions were used in any of the life calculations. The effect of an altitude split on the current part lives was reported in Reference 7.

Rotor Speed

The power-on rotor speed was 230 rpm and the power-off rotor speed was 261 rpm for each mission profile.

Part lives from the design mission profile, Reference 6, are influenced by too many factors other than the mission profile to draw any conclusions as to the effect of the profile.

Because of fatigue design criteria changes which occurred since the initial evaluation of fatigue lives in Reference 6, the component lives of Table VI are not directly comparable. Specifically, the endurance limits used for design mission profile calculations only considered bottom of scatter strength, whereas the other calculations additionally considered statistically significant values.

The current mission profile, Reference 4, produces extremely conservative fatigue lives relative to those obtained from the derived operational mission profile on five of the six components. The aft pivoting actuator life is identical for both of these profiles. Table VII shows that nearly half of the damage to the actuator occurs at 120% V_{ne} for the derived profile, while the maximum airspeed in the current profile is 110% V_{ne} .

The AR-56 mission profile fa lives are approximately
two times those of the curre ion profile for five of
the six parts, but a similar s indicated for the aft
pivoting actuator.

The strength of the aft rotor shaft appears to change in the wrong direction in Table VI. This is because the higher endurance limit is based on specimens which were shot peened to improve fatigue strength.

Fatigue lives for the aft rotor shaft assume that 5% of the operating time is with retracted longitudinal cyclic trim for each mission profile. Other components evaluated are not adversely affected by retracted cyclic trim.

To gain further visibility into the effect of mission profile on fatigue life, two components were selected for evaluation of fatigue load spectra and fatigue damage rate. The selected components were the aft rotor blade spar and the aft pivoting actuator.

TABLE VII. FATIGUE DAMAGE RATE FOR AFT ROTOR BLADE SPAR AND AFT PIVOTING ACTUATOR BY FLIGHT CONDITION AND MISSION PROFILE						
Operating Condition	Gross Weight lb	Mission Profile				
		Design	Current	AR-56	Derived	
		Occur- rence %	Occur- rence %	Occur- rence %	Occur- rence %	
Aft blade spar	Life =	50,100 Hr	4,920 Hr	8,930 Hr	52,550 Hr	
Pull-up 1.4g			0.05	0.04	0.025	
Pull-up 1.75g	28,550		3.0	1.5	0.001	
A/R pull-up			4.80	0.7	0.500	
Transition			78.4		69.7	
Level flight - 0.2V _H				1.76	41.6	
Level flight - 0.4V _H				0.72	17.2	
Sideward flight				0.36	3.4	
Rearward flight				0.16	1.5	
Accel to climb airspeed	33,000					
Pull-up 1.4g		0.5	10.6	0.16	5.5	
A/R pull-up				0.08	2.7	
Turn - hover				0.96	9.1	
Control Rev - hover				0.08	2.2	
Control Rev - long			8.0	0.40	11.2	
Control Rev - descent				0.12	3.4	
Aft Pivoting Actuator	Life =	1,400 Hr	1,340 Hr	1,470 Hr	1,350 Hr	
Level flight - 1.1V _H	25,000		0.40	0.09	0.800	
Level flight - 1.15V _H			3.1	8.1	10.0	
Level flight - 1.2V _H				0.04	0.300	
Pull-up 1.4g			0.05	2.0	0.200	
A/R pull-up	28,550		6.5	4.0	0.025	
Turn - left level				0.22	0.001	
Turn - right level			7.0	0.22	0.400	
Turn - left descent			0.1	0.22	0.400	
Control rev - lateral			0.7	0.02	0.2	
Control rev - direct, onal			0.3	0.10	0.130	
Control rev - descent			0.3	0.03	0.130	
Transition			81.2	0.10	0.3	
Level flight - 0.2V _H				1.76	0.500	
Level flight - 0.4V _H				0.72	10.1	
Level flight - V _H		10.0	78.6	38.2	38.0	
Level flight - 1.15V _H				0.36	1.2	
Level flight - 1.2V _H				0.36	0.7	
Sideward flight				0.16	0.1	
Rearward flight				0.36	19.7	
Accel to climb airspeed	33,000			0.16	0.3	
Pull-up 1.4g		0.5	21.4	0.16	2.5	
A/R pull-up			0.9	0.08	0.006	
Turn - hover				0.96	0.0	
Control rev - hover				0.08		
Control rev - directional			0.2	0.40		
Control rev - descent			0.2	0.12	0.040	

FATIGUE LOAD SPECTRA

Fatigue loadings for the CH-47A aft rotor blade spar and aft pivoting control actuator are shown in Figures 5 and 6 respectively. The loads are displayed in percent of endurance limit, and occurrence is expressed cumulatively in percent of time to reach or exceed. Only the high load, low occurrence portion of the curves is shown in order to improve data separation.

Looking first at the blade spar, there appears to be a close relationship in loads and lives for the current and AR-56 mission profiles. Similarly, the design and derived mission profiles have comparable shapes and nearly identical lives. The fact that resulting part lives differ by an order of magnitude is significant, and will be explored further in the Fatigue Damage Rate section.

The occurrence of higher loads on the blade spar with the design mission profile requires explanation. An extensive review of fatigue methodology was conducted at Boeing Vertol subsequent to the life calculations of Reference 6. The culmination of this review was the current life calculations for the CH-47A presented in Reference 4. The review included a reevaluation of measured flight loads, and errors found in the original data reduction were corrected. The corrections included both increases and decreases in load values, and in the case of the aft blade spar, the maximum fatigue load was lower than originally reported.

The actuator fatigue load spectrum, Figure 6, exhibits a wide variation of loads above 110 percent of the endurance limit for the various mission profiles, but the resulting part lives are surprisingly similar. The Fatigue Damage Rate section provides further visibility into the specific conditions which cause fatigue damage. The load variation is attributed to the following:

- Design mission profile load spectrum is normalized to a higher endurance limit than the other mission profiles, as shown in Table VI.
- AR-56 mission profile loads at 115% V_H are greater than those of the current mission profile.
- Derived mission profile maximum loads occur at 120% V_H and in the 1.75 g pull-up maneuver conditions which are peculiar to this profile.

The actuator fatigue life is approximately 1,400 hours as calculated, using four different mission profiles. The fatigue load spectra resulting from the four mission profiles are

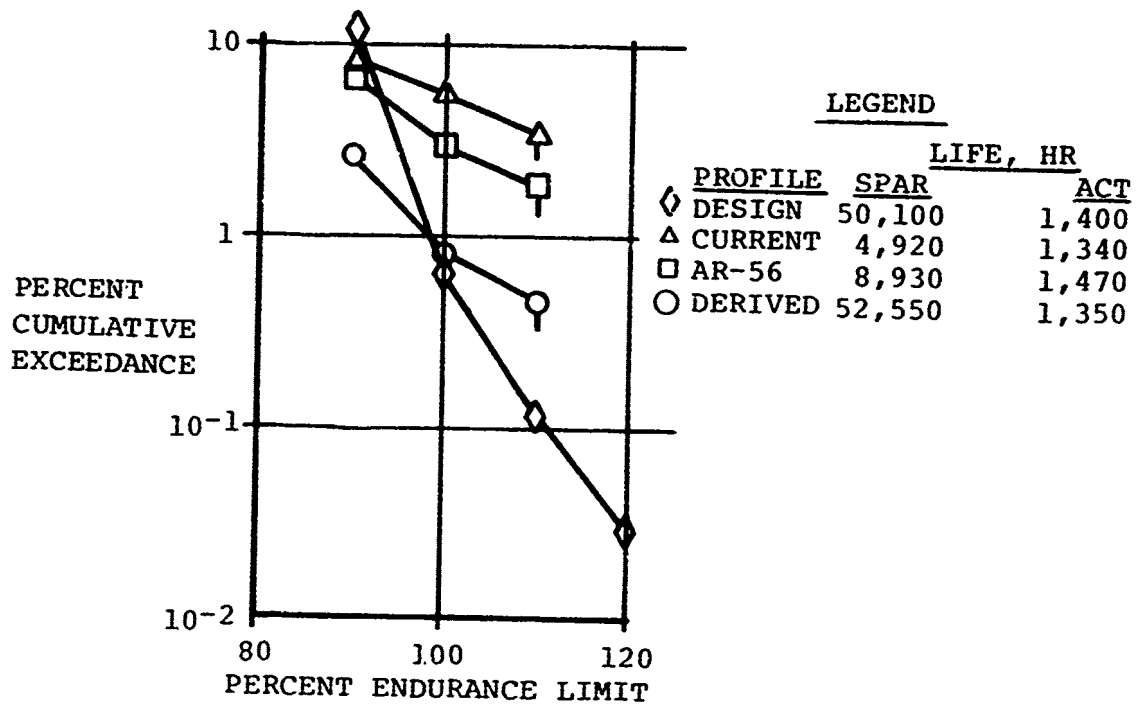

Figure 5. CH-47A Aft Rotor Blade Spar Fatigue Load Exceedance for Four Missions Profiles.

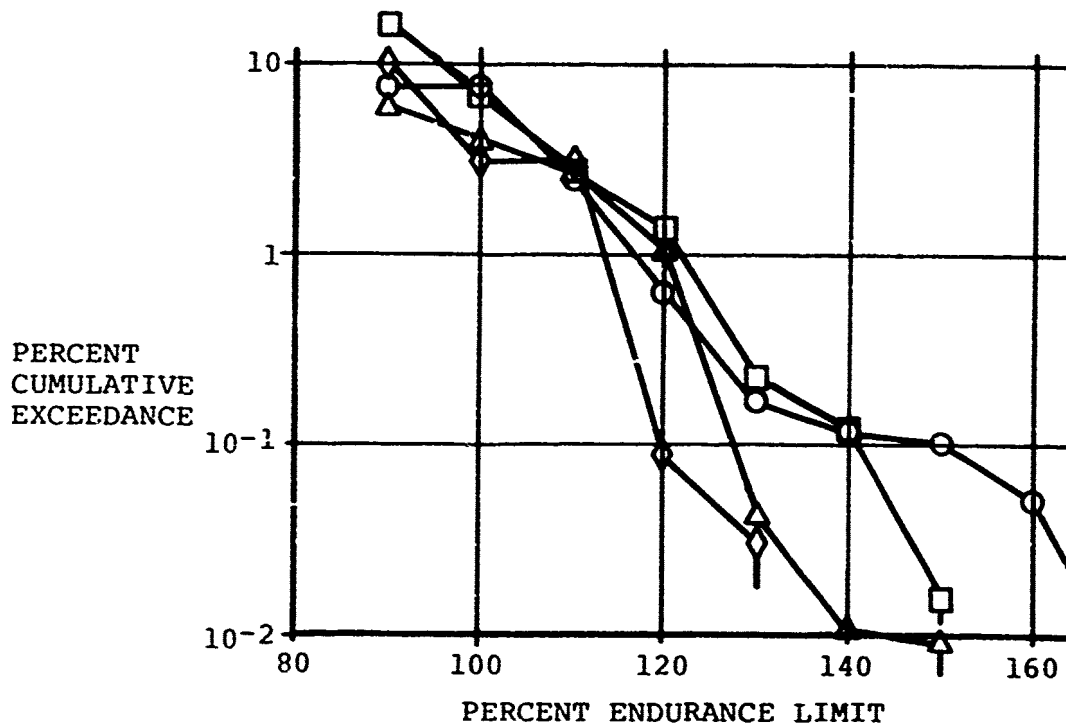

Figure 6. CH-47A Aft Pivoting Actuator Fatigue Load Exceedance for Four Mission Profiles.

nearly identical at 110% endurance limit and exhibit rather large dispersion at greater load values. These observations emphasize the importance of designing for fatigue strength greater than the loads expected in frequently encountered flight conditions.

FATIGUE DAMAGE RATE

Table VII summarizes the fatigue damage for the blade spar and control actuator for each mission profile by flight condition. Fatigue damage is expressed in percent of total fatigue damage for each mission profile element, and the corresponding occurrence in percent from Table V is shown for reference (gross weight for AR-56 is distributed the same as current mission profile). The calculated part life is also shown for reference.

As previously discussed, fatigue damage for the design mission profile was calculated using different methodology than the other mission profiles. In addition, the limiting airspeed envelope for the design profile calculations was approximately 10% greater than the current airspeed restriction for the CH-47A. It is concluded that the design profile is a poor basis for comparison in this study.

It is not surprising that components with low fatigue lives experience fatigue damage in steady state flight conditions. Elimination of fatigue damage in transition and level flight from Table VII would increase all calculated lives to at least 4200 hours.

A 1.75g pull up was included in the derived mission profile at an occurrence consistent with the load factor frequency experienced in the operational load surveys. Figure 3 shows the load factor spectrum of the derived mission profile relative to the operational data. Because of the very low occurrence, the effect of the 1.75g pull up on fatigue life is insignificant as shown in Table VII.

MISSION PROFILE RELATIONSHIP TO FATIGUE LIFE

From the analyses in this section, several conclusions can be made with respect to mission profiles and component fatigue lives:

1. Design fatigue strength for safe-life should insure that no fatigue damage is incurred in steady flight conditions or in transient conditions which are frequently encountered. Based on CH-47A loads and S-N curves for common metals, transient conditions of 10 seconds or less which occur less than once in 10 flight hours need not be considered in fatigue design. Calculated design fatigue loads should be amplified by a credibility factor for the load analysis

method. Procedures for establishing a credibility factor are required.

2. Fatigue damage tracking of critical safe-life components may be an effective method of increasing the utilization of components.
3. CH-47A component retirement lives are conservative based on the operational data available.

4. AIRCRAFT CONFIGURATION

A review of the developmental history of the CH-47 helicopter was conducted with the objective of determining the extent to which mission profile changes affected configuration changes of dynamic components.

The study was initiated by reviewing all Engineering Job Sheets (EJS) and Engineering Change Proposals (ECP). The EJS was the predecessor of the ECP, and these combined documents define all of the major changes to the CH-47A,B, and C helicopters as formally proposed to the Army by the Boeing Vertol Company.

Not all EJS and ECP are accepted by the Army. This study was limited to the company proposals which the Army approved. All changes involving rotor blades, hubs, drive, and control system components were included in the study.

Since the interest in this study is the effect of aircraft usage on dynamic component changes, the Service Revealed Difficulty (SRD) documentation was also reviewed. All changes of interest resulting from investigation of 85 SRD's were implemented by either EJS or ECP action. Therefore, the SRD review produced no new information relative to this study.

Minor changes to the aircraft can be accomplished through drawing changes without EJS or ECP action. In order to avoid an oversight of significant changes, a review of the history of assembly drawing changes was conducted. As with the SRD review, no new useful information relative to the study was obtained from the drawing review.

EJS/ECP ANALYSIS

A total of 207 approved EJS and ECP changes in the dynamic system were identified. The changes were classified into eight categories chosen to provide a general description of the reason for the change. Table VIII quantitatively summarizes the analysis of the changes.

TABLE VIII. SUMMARY OF 207 CH-47 CHANGES BY HELICOPTER SYSTEM AND REASON FOR CHANGE

Reason for Change \ System	Number of Changes			
	Blades	Hubs	Drive	Controls
1. Material, manufacturing and maintenance improvements	4	2	4	3
2. Environmental protection (sand, dirt, corrosion)	1	2	-	-
3. Lubrication and cooling improvements	-	1	19	3
4. Joint retention improvements	-	-	12	2
5. Reduce friction, improve sensitivity, improve damping, eliminate interference	-	-	-	33
6. Wear improvements - bearings and gear teeth	-	4	31	5
7. Fatigue strength improvements	8	10	25	24
8. Ultimate strength improvements	3	1	3	4
Totals	19	20	94	74

Classification of the changes was difficult in many cases, since subjective judgements were involved. It was desirable for analysis purposes to assign only one reason for each change. Obviously, some changes could be identified with more than one of the classifications shown in Table VIII. A control interference, for example, could possibly affect strength and be classified as a fatigue strength improvement, ultimate strength improvement, or both fatigue and ultimate strength improvements. In this analysis the classification selected was the one which appeared to be the primary reason for initiating the change proposal.

The changes made for fatigue and ultimate strength improvement are further summarized in Table IX. Two changes which separately define fatigue strength improvement by shot peening of the forward and aft rotor shafts are clearly related to service usage. The changes were made following analysis of the operational data reported in References 2 and 3. Two operational factors contributed to the reduction in fatigue life and resulted in the need for change: flight at airspeeds in excess of Operator's Manual limitations, and flight with longitudinal cyclic trim retracted (failed trim actuators). The airspeed exceedance was identified from the operational data. The failed trim actuator condition became apparent based on pilot reports, field service engineer reports, and a study of actuator malfunction frequency.

Twelve of the identified fatigue strength changes resulted from planned growth of the CH-47 helicopters. The structural flight limitations for the CH-47A, CH-47B, and CH-47C at 6,000 feet density altitude are compared in Figure 7. The need for greater payload than the CH-47A could produce became apparent during the combat operations in Southeast Asia. Structural changes associated with model changes were based on operational need. This should not be confused with changes resulting from operational use.

The balance of strength improvements in Table IX resulted from either developmental tests or service failures. Developmental tests include static and dynamic bench tests as well as flight tests, and bear no relationship to operational use of the helicopter. Changes which result from service failures could be attributed to operational use, but not necessarily so. In many cases the distinction between design deficiency, manufacturing defect, operational use, and operational mis-use is hard to define, and quite often is influenced by the perspective of the one making judgement. There were insufficient facts available in most of the service-related changes to determine the influence of operational use on the service failure.

TABLE IX. SUMMARY OF CH-47 CHANGES TO IMPROVE FATIGUE AND ULTIMATE STRENGTH OF COMPONENTS

System	Reason for Change	Number of Changes	Change Results From	Change Description
Rotor blade	Fatigue strength	4	Service failure (blade loss)	Blade socket incidence pin hole corrected for manufacturing defect (burr), improved corrosion protection, re-oriented to reduce loads
		3	Developmental tests	Blade trailing edge redesigned to improve fatigue strength
		1	Aircraft growth	New blade design for CH-47B and CH-47C
		3	Developmental tests	Rotor blade tip cover and balance weight retention improvements
Rotor hub	Fatigue strength	8	Developmental tests	Droop stop changes to minimize droop stop contact and increase local fatigue strength
		2	Aircraft growth	Vertical pin joint and lag dampers redesigned for CH-47B and CH-47C
		1	Service failure (blade struck fuselage during high wind shutdown)	Droop stop redesign to reduce aft blade static droop angle

TABLE IX. Continued

System	Reason for Change	Number of Changes	Change Results From	Change Description
Drive	Fatigue strength	3	Developmental tests	Transmission pinion gears shot peened to improve fatigue strength
		4	Developmental tests	Transmission planet bearing retainer redesigned to improve fatigue strength
		4	Developmental tests	Transmission pinion gears redesigned to eliminate resonance
		2	Service failure (cracks)	Thrust bearing retainer redesigned to improve fatigue strength
		1	Service failure (power loss)	Engine quill shaft redesigned to improve fatigue strength
		1	Service failure (power loss)	Engine transmission spiral bevel ring gear redesigned to improve fatigue strength
		2	Service failure (cracks)	Synchronizing shaft adapter redesigned to improve fatigue strength
		2	Service usage	Rotor shafts shot peened to improve fatigue strength
		6	Aircraft growth	Transmissions and shafts redesigned for CH-47C

TABLE IX. Continued

System	Reason for Change	Number of Changes	Change Results From	Change Description
Drive		1	Developmental tests	Engine drive shaft balance weight retention strengthened
		1	Developmental tests	Aft transmission housing strengthened to react unscheduled rotor lock engagement
	Ultimate strength	1	Service failure (ground power loss)	Auxiliary gearbox quill shaft strengthened to react loads due to clutch malfunction
Control		3	Developmental tests	Longitudinal cyclic trim schedule changed to reduce hub and shaft loads
		1	Developmental tests	SAS authority changed to reduce control system fatigue loads
	Fatigue strength	11	Developmental tests	Fixed control system components redesigned to improve fatigue strength
		2	Developmental tests	Rotating control system components redesigned to improve fatigue strength
		3	Aircraft growth	Controls redesigned for CH-47B and CH-47C

TABLE IX. Continued

System	Reason for Change	Number of Changes	Change Results From	Change Description
Control	Fatigue Strength	4	Service failure (cracks)	Drive collar (3) and pitch link protective cover (1) redesigned to improve fatigue strength
	Ultimate strength	3	Developmental tests	Lower controls redesigned to react parked blade loads
		1	Service failure	Collective pitch control magnetic brake (trim device) redesigned to react pilot loads

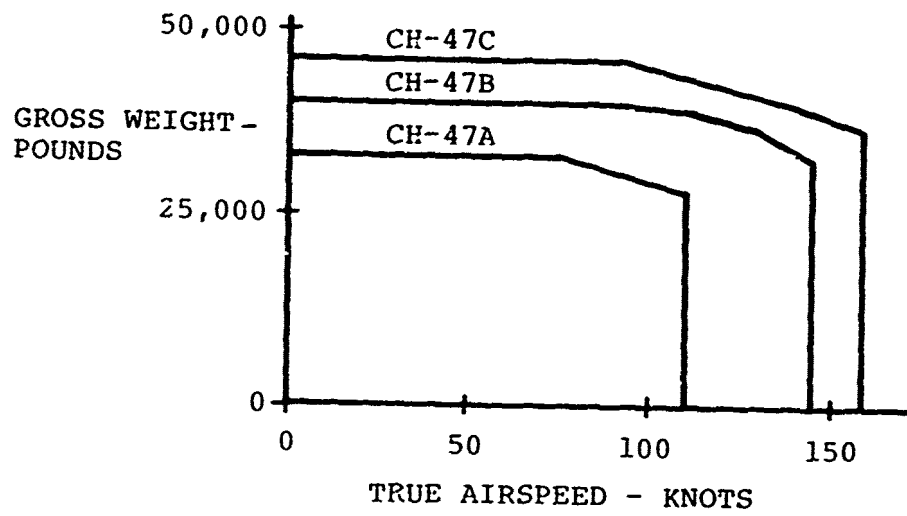

Figure 7. Structural Airspeed Limitations for CH-47 Helicopters at 6,000 Feet Density Altitude.

The effect of aircraft usage on component fatigue lives can be made by comparing the calculated lives documented in References 4 and 6. A sample comparison is shown in Table VI, and it is evident that significant reductions in part life occurred. As discussed in Section 3, the current mission profile of Reference 4 was not the only factor affecting reduction in part life. The most important difference between the two mission profiles is the high speed level flight condition. The design mission profile assumed that the airspeed limitations of the Operator's Manual would not be exceeded, while the CH-47A operational data shows that this airspeed was frequently exceeded. Flight with failed longitudinal cyclic trim actuators affects the fatigue loads on some components, in particular, the rotor shafts.

DISCUSSION OF RESULTS

Operational use of the CH-47A as compared to the design mission profile led directly to the rework of the forward and aft rotor shafts and contributed to reduced retirement lives for several dynamic system components. Exceedance of the airspeed limitations of the Operator's Manual is cited as the principal cause of the reduced fatigue lives. The failure mode of a control trim device also contributed to the rotor shaft rework requirement.

The experience gained in evaluating the operational use of the CH-47A helicopter was used in the development of the CH-47B and CH-47C models. The structural performance of the growth models shows a great improvement over the CH-47A, at least a part of which should be attributed to the CH-47A operational experience. No operational survey has been conducted on the B and C models, however, so the adequacy of their mission profiles cannot be evaluated.

5. OPERATING LIMITATIONS

An attempt is made in this section to determine the factors which limited operational use of the CH-47A, and to project the effect of various limitations on the use of future cargo- and transport-type helicopters.

Steady state mission time from the Reference 1 data gathered in the United States (USA) and from the Reference 2 data gathered in Southeast Asia (SEA) was analyzed with respect to gross weight, airspeed, and altitude. The operational measurements were compared to the Operator's Manual limitations, power limits, and vibrations.

Flight duration and the rotor start-stop cycle were briefly examined.

Finally, the load factors experienced in the USA and SEA were examined to evaluate the suitability of the design load factor.

Two factors which may be significant to this study cannot be evaluated:

1. The effect that external cargo stability may have had on airspeed.
2. The influence of a monitor system on crew performance. This has always been a nagging problem in field survey work, although the data analyzed herein did not appear to be biased to hide airspeed exceedance of operating manual limitations.

Power limited airspeeds were calculated for both normal and military power. However, it was only necessary to include normal power values in the analysis. The power values were determined at International Standard Atmosphere (ISA) conditions, which approximate the USA data atmosphere, and at ISA +20°C, which more nearly represents the SEA operations.

The limitations of the TM55-1520-209-10 Operator's Manual were copied directly from the Manual. These limitations were established from the fatigue load to strength relationship as determined in contractor developmental bench and flight tests.

The vibration environment in the cockpit was estimated in terms of a pilot comfort index. Values of the index are shown on the plots where this index is used. Vibration levels are displayed as a scatter band varying with airspeed but independent of gross weight and altitude.

STEADY-STATE OPERATIONS

The steady-state segments of USA and SEA data are presented in Figures 8 and 9 for gross weights below and above 28,000 pounds respectively. In the figures, the flight times are expressed as percent of total steady-state flight time in the weight category. The upper portion of each figure breaks up the data into altitude and airspeed blocks which are compared to normal power and to the limits of the Operator's Manual. The lower portion of Figures 8 and 9 have a pilot comfort index shown relative to the operational data sample with all altitudes grouped together.

The first observation to be made on Figures 8 and 9 is that the CH-47A limits in the Operator's Manual are less than those attainable with normal power (twin engine) for nearly all operating conditions. The relationship of power limits to other limits in the operator's manual may be important in projecting aircraft usage, and analysis of operational data should consider the relationship.

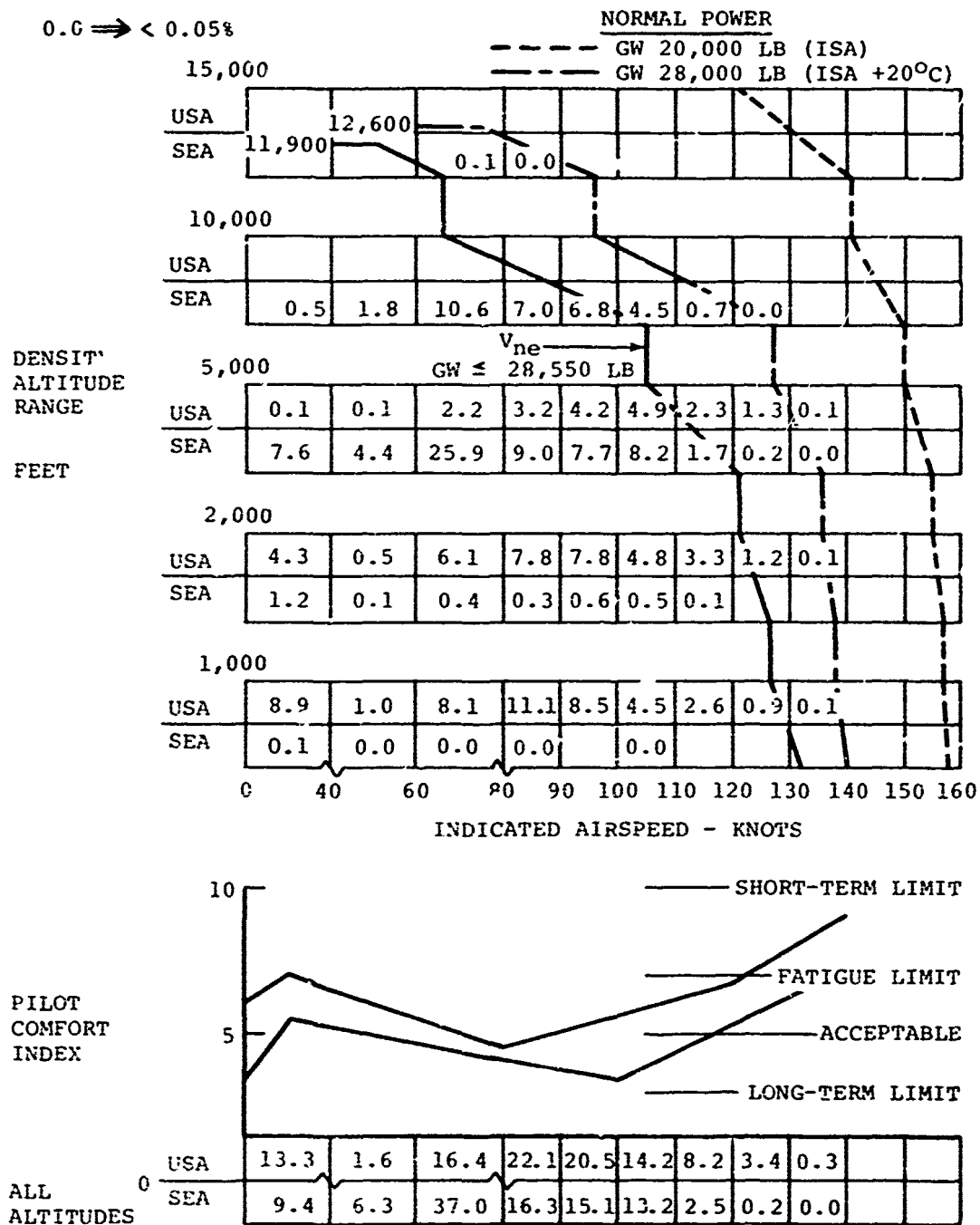

Figure 8. Percent of Steady-State Time for 98.2 Hours (USA) and 135.9 Hours (SEA) of CH-47A Operational Data at Gross Weights Below 28,000 Pounds.

0.0 ⇒ < 0.05%

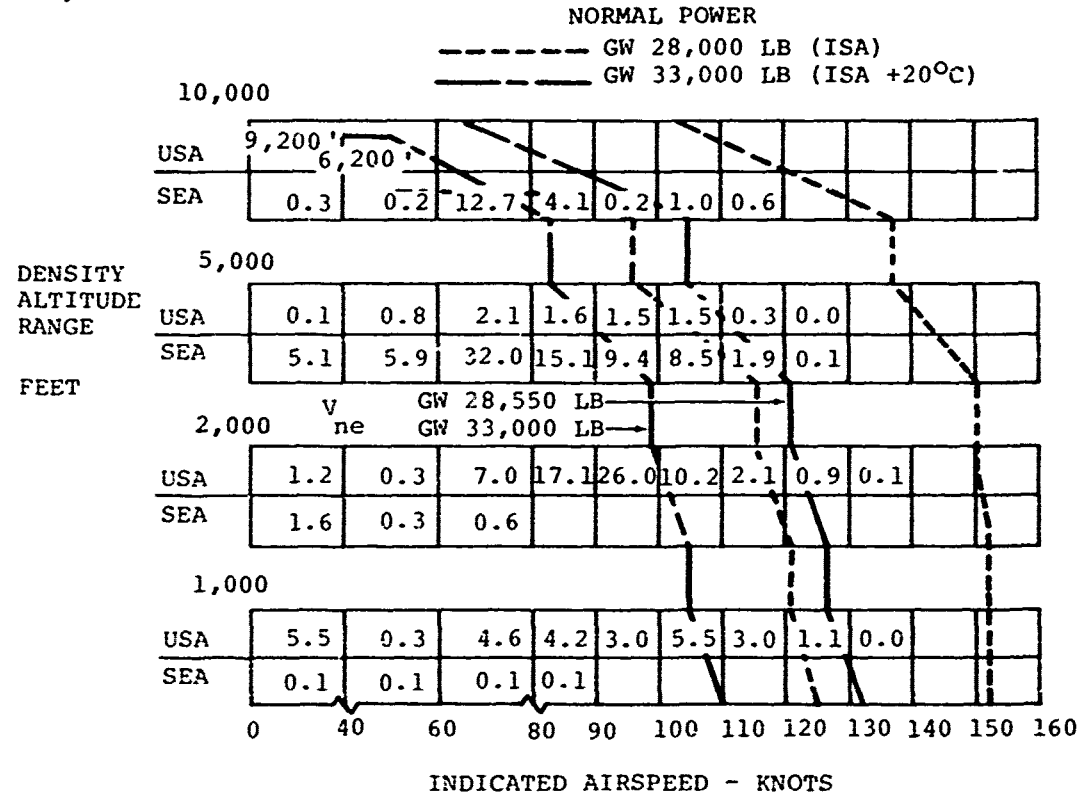

Figure 9. Percent of Steady-State Time for 9.4 Hours (USA) and 18.9 Hours (Sea) of CH-47A Operational Data at Gross Weights Above 28,000 Pounds.

The limits of the Operator's Manual were frequently exceeded in both the USA and SEA data sets, while all of the data could be within normal power limits. The power observation does not imply that the pilots never exceed normal power, but simply that high power settings were not usually required for steady level flight.

Airspeed occurrence fell off rapidly above 110 knots, nearly independent of altitude and gross weight. Above 110 knots the pilot comfort index suggests that vibrations can reach pilot fatiguing levels.

The frequent exceedance of the airspeed limitations of the Operator's Manual is a cause for concern, since component fatigue lives are generally reduced by this excessive airspeed. Since it is not logical that pilots would willfully violate manual limits, it must be assumed that the limits are either not understood or are too difficult to comply with in combat operations.

FLIGHT DURATION AND THE ROTOR START-STOP CYCLE

A review of the rotor start frequency and number of flights showed that the average flight was very short. The short flight duration was consistent with the high occurrence of time at low airspeeds. The flight and rotor start data are shown below:

	<u>No. of flights</u>	<u>No. of flt hrs</u>	<u>No. of rotor starts</u>	<u>Average flight</u>	<u>Avq start cycle</u>
USA	769	165	230	12.9 min	43.0 min
SEA	1081	235	395	13.0 min	35.7 min

MAXIMUM LOAD FACTOR

The maximum load factors experienced in the operational data are presented in Figure 10. The USA and SEA data samples were very similar, and each gives the impression that the CH-47A could have been designed to a much lower load factor. The problem with arriving at such a conclusion is the uncertainty of the adequacy of the data sample to represent the long-term exposure of a full fleet of aircraft. In Figure 11 the data of Figure 3 is replotted with an exponential extrapolation of the mean of the data. The contractor's demonstrated load factors are shown for reference. The extrapolation, which is only one of several possibilities, suggests that exceedance of the positive design load factor would occur around 10 million total flight hours. The CH-47 fleet has logged over 1.2 million flight hours as of October 1972. Other extrapolations of the data could lead to the conclusion that the CH-47 should have been designed to a higher load factor.

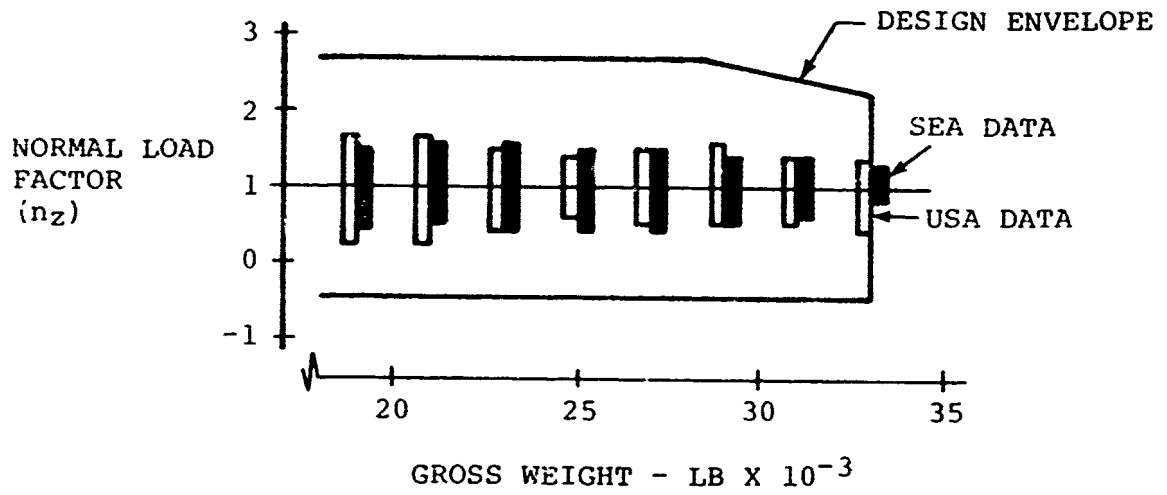

Figure 10. CH-47A Maneuvering Load Factors Relative to Design Envelope.

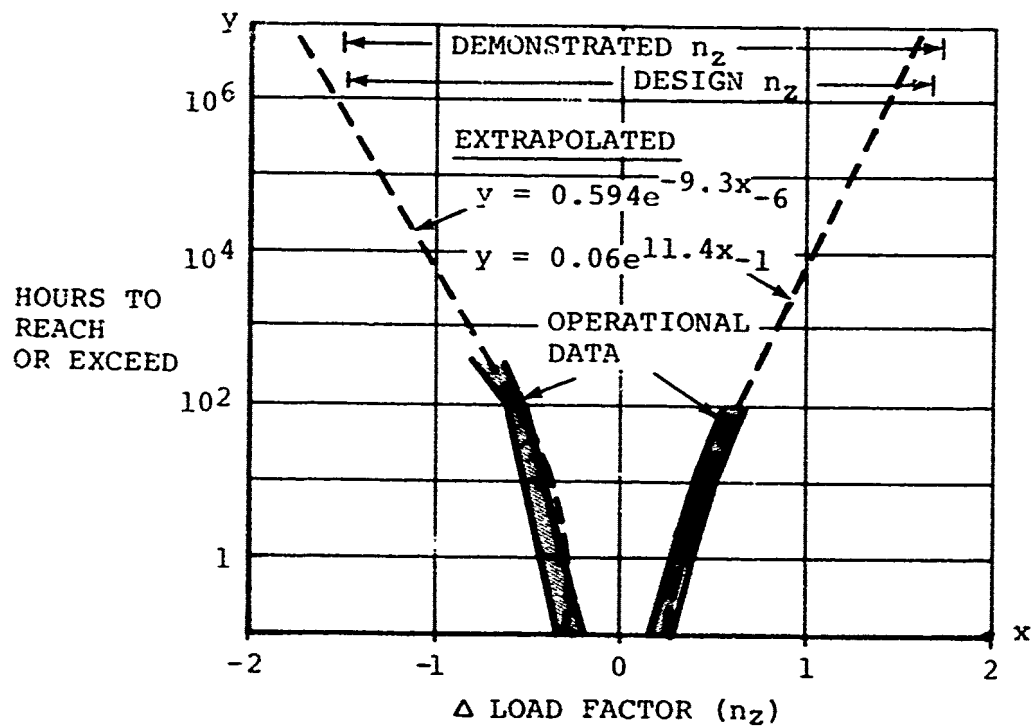

Figure 11. Operational Load Factors Extrapolated to High Flight Hours.

The design load factor for the CH-47A was based on the thrust capability of the rotors. The demonstrated load factors on the CH-47 models were the extremes that the pilot could attain for the required demonstrations. Therefore, if the required demonstrations were properly chosen, it is not possible for a fleet pilot to exceed the demonstrated values. This reasoning leads to the conclusion that the extrapolated load factors of Figure 11 should become asymptotic to the demonstrated load factors.

SUMMARY OF OPERATING LIMITATIONS

From the data presented in this section, the following conclusions may be extracted for use in future cargo- and transport-type helicopter design:

1. Frequent flights of 10 to 15 minutes duration can be expected.
2. Rotor start-stop cycles may average up to 2.0 per flight hour.
3. Structural limitations should exceed power capability for all primary missions. Improved methods of providing a cockpit display of structural limitations are desirable in order to avoid overdesigning of rotor systems.
4. Vibration attenuation should improve pilot comfort and confidence in the aircraft, and should not be a factor in limiting operations in future designs.
5. Helicopters should be designed to sustain flight loads within the transient capability of the rotor system. The inherent versatility of helicopters to perform a wide range of missions could be compromised if the aircraft are designed to less severe criteria.

6. CONCLUSIONS AND RECOMMENDATIONS

Analysis of the separate studies of Sections 2 through 5 leads to the following conclusions and recommendations for structural design criteria for cargo- and transport-type helicopters. Because of limitations identified in the CH-47A usage data, recommendations are also submitted for future acquisition and analysis of operational data.

STRUCTURAL DESIGN CRITERIA

1. Design load factors should be based on the maximum transient thrust capability of the rotor system. As shown in Section 5, the operational data does not support an argument for reducing the design load factor to a lesser value. No historical evidence was found to suggest that greater strength is required. With this design criteria, the maximum design load factor would be determined at the minimum operational gross weight.
2. The minimum load factor of 2.0, as specified in MIL-S-8698, appears conservative when compared to the operational data. If the entire helicopter is designed to react the transient thrust capability of the rotor system, as recommended in the preceding paragraph, no minimum positive design load factor is required. Structural safety will be maintained for any operations within the performance capability of the helicopter.
3. Fatigue mission profiles should be simplified for helicopter design. Attaining part lives in excess of 5,000 hours is not likely if fatigue damage is incurred in any steady flight condition, as shown in Section 3. Transient conditions of less than 10 seconds duration which occur less than one time in 10 flight hours usually need not be considered in the fatigue design of most metallic dynamic components. The requirements for fatigue design should include the following:
 - Listing of steady flight conditions required to perform the design mission(s). Include steady bank angle and sideslip requirements.
 - The frequency, duration, and severity of transient flight conditions required to perform the design missions.
 - The payloads, airspeed range, and design altitude for steady and transient flight conditions.

4. Fatigue mission profiles for life calculations should be based on design flight conditions and reevaluated by conducting surveys of actual helicopter operations. The CH-47A experience clearly indicates the need for reevaluating mission profiles, as evidenced by the reduction in part lives due to exceedance of Operating Manual limitations. Concepts for control of fatigue damage other than operational surveys include:
 - Cockpit display of fatigue loads. The Cruise Guide Indicator (CGI) is a suitable device, but it has no capability to assess fatigue damage. The need for such a display is apparent in Sections 4 and 5.
 - Direct monitor of fatigue damage to critical components.
 - Fail-safe design which provides a secondary load path and suitable detection and warning of a primary load path failure.
5. Flight times and rotor start-stop cycles should influence the fatigue mission profiles. The CH-47A operational data indicate that frequent flights of 10-15 minutes duration can be expected, and 1.5 to 2.0 rotor start-stop cycles per flight hour should be considered (Section 5).
6. Vibration criteria should insure that operations are not restricted due to crew or passenger comfort. It was concluded in Section 5 that pilot comfort had a strong influence on the maximum airspeeds attained in operational use. However, improved vibration attenuation techniques developed after the CH-47A should eliminate this constraint on future helicopters.

OPERATIONAL DATA ACQUISITION AND ANALYSIS

During the review of operational data, several shortcomings were found in the types of measurements and analysis techniques for use in assessment of fatigue exposure. The following recommendations are made for future acquisition and analysis of operational data:

1. The data sample should include a complete cross section of operating conditions, such as training and operational squadrons in various parts of the world.
2. The measurement list should be tailored to meet the needs of fatigue assessment. Direct measurement of loads in fatigue critical components should be considered.
3. Recording systems compatible with automated data reduction and analysis are desirable.

4. The data should be reduced in a format appropriate to the intended analysis to be performed.

7. LITERATURE CITED

1. Braun, J.F., et al, CH-47A Chinook Flight Loads Investigation Program; USAAVLABS Technical Report 66-68, U.S. Army Aviation Materiel Laboratories, Fort Eustis, Virginia, July 1966.
2. Geissler, F.J., et al, Flight Loads Investigation of Cargo and Transport CH-47A Helicopters Operating in Southeast Asia; USAAVLABS Technical Report 68-2, U.S. Army Aviation Materiel Laboratories, Fort Eustis, Virginia, April 1968.
3. Investigation of Impact of RVN Flight Survey Data on Fatigue Critical Components, Boeing Report 114-SS-025, July 1968.
4. Dynamic Component Fatigue Life Evaluation, CH-47A Helicopter, Boeing Report 114-SS-001, March 1966.
5. Structural Design Requirements (Helicopter), Naval Air Systems Command Aeronautical Requirement (AR)-56, 17 February 1970.
6. Boeing-Vertol CH-47A Helicopter Dynamic System Strength Substantiation Bench Test Data and Life Calculations, Boeing Report 114-T-112.2, January 1965.
7. CH-47A Helicopter Dynamic Component Life Evaluation for Flight Envelope, Boeing Report 114-SS-002, December 1965.